



ARTICLE

Tuning the Spatially Controlled Growth, Structural Self-Organizing and Cluster-Assembling of the Carbyne-Enriched Nano-Matrix during Ion-Assisted Pulse-Plasma Deposition

Alexander Lukin^{1,*} and Oğuz Gülseren²

¹Integrated Carbon Nano-Systems Lab, Western-Caucasus Research Center, Tuapse, 352808, Russian Federation

²Department of Physics, Bilkent University, Çankaya, Ankara, 06800, Turkey

*Corresponding Author: Alexander Lukin. Email: lukin@wrcr.ru

Received: 17 February 2022 Accepted: 30 March 2022

ABSTRACT

Carbyne-enriched nanomaterials are of current interest in nanotechnology-related applications. The properties of these nanomaterials greatly depend on their production process. In particular, structural self-organization and auto-synchronization of nanostructures are typical phenomena observed during the growth and heteroatom-doping of carbyne-enriched nanostructured metamaterials by the ion-assisted pulse-plasma deposition method. Accordingly, fine tuning of these processes may be seen as the key step to the predictive designing of carbyne-enriched nano-matrices with improved properties. In particular, we propose an innovative concept, connected with application of the vibrational-acoustic effects and based on universal Cymatics mechanisms. These effects are used to induce vibration-assisted self-organized wave patterns together with the simultaneous manipulation of their properties through an electric field. Interaction between the inhomogeneous electric field distribution generated on the vibrating layer and the plasma ions serves as the additional energizing factor controlling the local pattern formation and self-organization of the nano-structures.

KEYWORDS

Carbyne-enriched nanomaterials; ion assisted pulse plasma deposition; carbon sp-chains; stabilization of sp-hybridized carbon; sp-encapsulating; heteroatom-doping; vibrational-acoustic activation; vibrational patterns; electromagnetic activation; nanoscale self-organization; standing surface acoustic waves; nano-Cymatics; predictive patterning

Nomenclature

AFM	Atomic force microscopy
CAPD	Cathodic arc plasma deposition
CAW	Carbon-atom wire
PVD	Physical vapor deposition
SEM	Cross-section scanning electron microscopy
Sp hybridization	Linear structure in molecules
TEM	Transmission electron microscopy



1 Introduction

Ideal one-dimensional form of carbon, a carbon allotrope—an infinitely long the linear chain of carbon atoms, named as a carbyne, attracted much interest due to advanced mechanical and physicochemical properties, including mechanical strength predicted to be an order of magnitude higher than that of diamond [1–3]. Like a graphene, carbyne is just one atom thick, which gives it an extremely large surface area in relation to mass. Carbyne was first described in 1885 by Adolf von Baeyer.

Many types of carbonaceous material, such as nano-diamonds, interstellar graphite, pyro-carbons, fullerenes as well as carbyne crystals have been discovered from some carbonaceous meteorites. Back in the 1930s, astronomers discovered carbynes as one of the first molecules in interstellar space. Later, astronomers have found signs of the presence of cosmic carbyne crystals in interstellar dust clouds. One of possible routes for the formation of cosmic carbyne crystals from the carbonaceous dust are connected with intensive synchrotron radiation under a coronal photon flux in the interplanetary medium. In this connection, carbyne crystals can be considered as out-of-this-world interstellar material. The unique space environment along with intensive electromagnetic and radiation fields and microgravity conditions provides ideal conditions for the growth of the carbyne crystals that are more perfect than their counterparts grown on Earth. The Earth-grown carbyne crystals usually contain defects that induce instability of the crystal structure. Research has shown that crystal growth in microgravity conditions has a benefit due to the lack of buoyancy-induced convection, which affects transport of molecules in the crystal.

Unique combination of extraordinary properties of the carbyne-enriched nanostructured metamaterials offers a fascinating material platform for the development of next-generation technologies in many areas: superfast electronics, ultrasensitive sensors, multifunctional composites and coatings, membranes, medicine and biotechnology, energy storage matrices like batteries and supercapacitors, where the surface area of the electrode determines energy density. The list of key application areas of the carbyne-enriched nanostructured metamaterials is shown in Fig. 1.

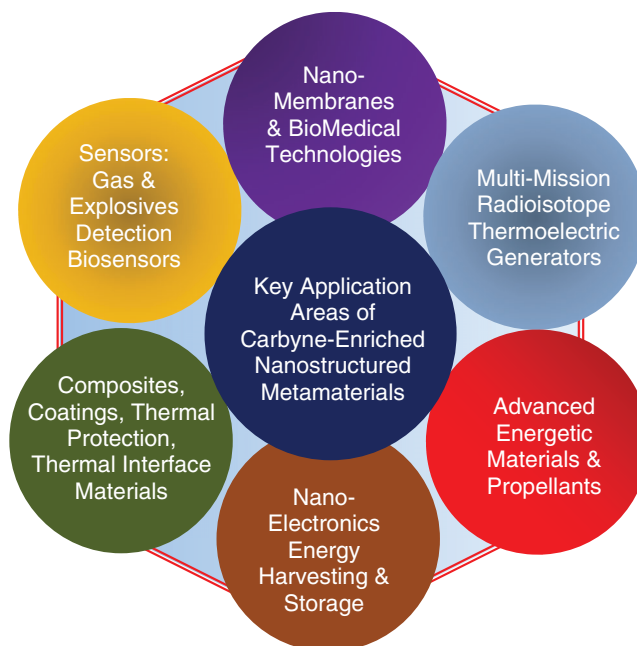

Figure 1: Key application areas of the carbyne-enriched nanostructured metamaterials

Among such applications are the following: electronic thermal protection systems; functionalized nano-sized additives for energetic materials and propellants; metamaterials for supercapacitor applications; next generation of solar cells based on carbyne-enriched metamaterials; carbyne-enriched metamaterials for multi-mission radioisotope thermoelectric generators; carbyne-enriched metamaterials for active nano-membranes that allow continuous tuning of their functional parameters to target molecules by changing the parameters of the electric field in the pores. Carbyne-enriched nano-structures are critical for sensing applications, as they have unique physical and electronic properties which permit detection of substances in solutions, gaseous compounds and pollutants.

The properties of the carbon-based nanostructured metamaterials essentially depend on their spatial structure. Differently hybridized carbon atoms are capable of forming diamond, graphite, linear-chain grids and many other specific allotropes. Each carbon allotrope has notably different electronic and mechanical properties. The electronic structure of a linear-chain carbon molecule includes two kinds of bonds: the (σ) bond provides mechanical stability to the linear-chain carbon molecule, and the (π) bond, in addition to mechanical stability, provides the electrical properties of this nanostructure, since the π -electrons are delocalized and belong to the entire chain of atoms. The electronic structure of a fragment of a linear-chain carbon molecule section is shown in Fig. 2.

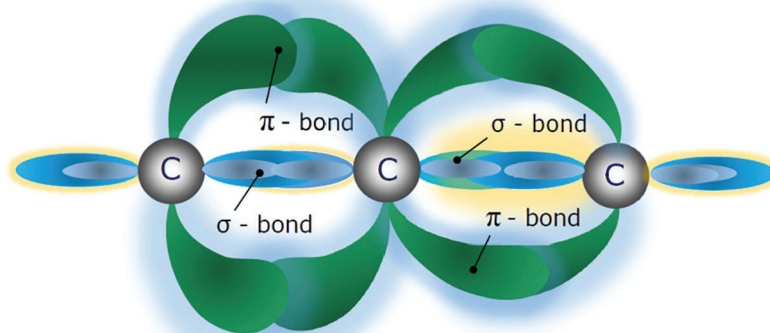

Figure 2: The electronic structure of a fragment of a linear-chain carbon molecule section

Carbon allotropes can function either as a conductor, in sp -1 chains, carbynes, and sp -2 planar structures, graphene and graphite, or as a wide-gap insulator in sp -3 tetrahedral coordination, e.g., diamond and alkanes. The first two have the potential to form bonds that are electrically conducting, while sp -3 has insulating properties. For instance, carbon nanotubes demonstrate remarkable electrical conductivity and anisotropic electromagnetic characteristics. The existence of the cosmic carbene crystals can be used as a key to its formation mechanism and environments experienced by it and additionally confirms the presence of a factor of self-organization in the carbon chains growth.

Linear chains are present in carbon vapors at temperatures above 5000 K. The technology for growing this unique carbon nanostructured metamaterial is enough simple: it self-organizes during condensation from the carbon vapor in a vacuum at temperature above 3150 K. However, pure carbyne in the condensed phase is extremely unstable due to its high chemical reactivity. The growth of the macroscopic crystals of the carbyne is inhibited by the instability and high reactivity of this allotropic form of carbon. Carbyne properties can be manipulated through the chain length, doping by nano-clusters, and by type of the chain termination. Nanostructure stability depends on the linear carbon chain's length. Free carbon-atom wires (CAWs) of any length must be terminated by molecular complexes to ensure their stability. For practical use of carbyne-enriched nanostructured metamaterials, the ability to ensure high stability of this

nanomaterial is of key importance. Most current research efforts concentrated on searching possibilities for stabilization of the sp -hybridized carbon chains.

The growth process determines the resulting properties of the carbene-enriched nanomaterials. The specific purpose of the presented research connected with further improvement of the ion-assisted pulse-plasma deposition technology for increased stability of the sp -hybridized carbon chains within the carbene-enriched nano-matrices.

2 Stabilization of the Sp -Hybridized Carbon Chains

During a long time attempts to grow the long carbene molecules were limited by its extreme chemical instability [3]. In 2016, scientists of University of Vienna have proposed and demonstrated a fundamentally new strategy to ensure the structure stability of the extremely long sp -hybridized carbon chains, containing more than 6000 carbon atoms through growing them within the long nano-matrices formed by the double-walled carbon nanotubes [4,5], see Fig. 3.

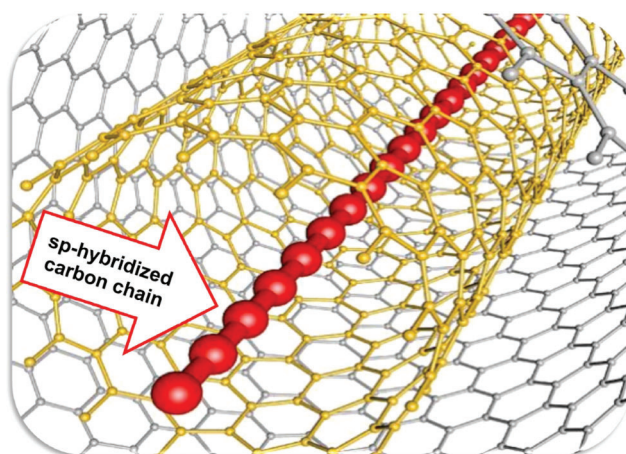

Figure 3: Schematic representation of stabilizing of the long one-dimensional carbene molecule inserted into the double-walled carbon nanotube

The double-walled carbon nanotubes provide efficient structure stabilizing of the encapsulated one-dimensional carbene molecule that is extremely important for designing the advanced functional nanostructured metamaterials. Such kinds of carbon nanotubes serve as nanoreactors and protect the sp -hybridized carbon chains from interaction with the environment. This outstanding result showed the new fundamental possibility of using the control of the nano-matrix spatial structure for programming the stability of the inserted sp -hybridized carbon chains.

The strategy, connected with the growth of the sp -hybridized carbon nanostructures in the composition of multi-cavity nano-matrices seems to be the most promising way for the creation of the advanced carbon-based nanostructured metamaterials.

The new alternative modification of this strategy, suggested in 2019, was connected with designing a new class of carbon allotropes obtained by combining linear sp -hybridized carbon chains with sp^3 bulk carbon through inserting of sp -hybridized chains into cylindrical nanocavities periodically arranged in hexagonal diamond [6].

Schematic representation of one of examples of stabilizing of sp -hybridized carbon chains through inserting into cylindrical nanocavities periodically arranged in hexagonal diamond is shown in Fig. 4.

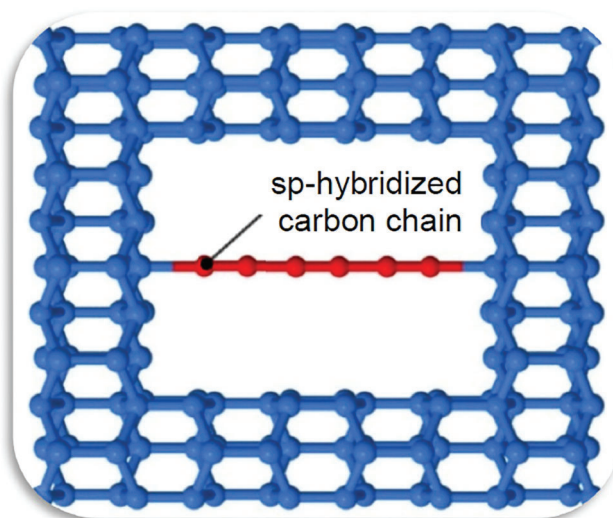

Figure 4: Schematic representation of stabilizing of sp-hybridized carbon chains (red-highlighted sp atoms) through inserting into cylindrical nanocavities periodically arranged in hexagonal diamond (blue-highlighted sp-3 carbon)

Since the sp-hybridized carbon chains are highly unsaturated, they have tendency to react with forming the extra bonds that leads to degrading into both sp² and sp³ structures. In this connection, it is possible to provide inserting and isolation of the sp-hybridized carbon chains inside the some enough both wide and long nanocavity, formed by the sp³ hybridized carbon, to prevent the sp-hybridized carbon chains spontaneous reaction and degrading. As such an insulating nanostructure was chosen the hexagonal-structured diamond that have enough long nanocavity along the axis. In the results was grown allotrope demonstrating characteristic high-frequency vibrations associated with the sp-hybridized chain stretching modes and having long-time stability at the room temperature environments.

Relatively recently, the research team of the Carbon Nano-Systems Lab at Physical Electronics Chair of the Physics Department of Moscow State University (V. G. Babaev, M. B. Guseva, O. A. Streletsky, V. V. Khvostov, N. F. Savchenko) were found new routes to compensate for the above disadvantages by encapsulating oriented linear chains of carbon atoms—the monatomic carbon filaments into the matrix of amorphous carbon, creating bends and controlling the end groups in the process of ion-plasma growth [7]. This is one of the most promising routes for obtaining of the stable carbyne-enriched nanostructured metamaterials, based with growing them within the composition of multi-cavity nano-matrixes through the ion-assisted pulse-plasma deposition from the carbon plasma [7].

This technique also opens possibilities for further increase of the long carbon chains stability through assembling them by atomic clusters of different chemical elements, for instance, Silver, Gold, Titanium, etc. Due to outstanding deposition possibilities: the layer-by-layer deposition, possibility of metastable carbon phase synthesis, low substrate heating and applicability for various substrate types, this tool-kit continues to be studied Worldwide.

Such kind of carbon nanostructured metamaterials were named as two-dimensionally ordered linear-chain carbon, which is a two-dimensionally packed hexagonal array of carbon chains held by the van der Waals forces with the interchain spacing approximately being between (4.8–5.03) angstroms [7].

Within such nano-matrix the carbon atom wires very weakly interacting with each other (due to Van der Waals interaction), and therefore, the properties of such nano-matrixes are actually determined by the properties of individual quantum wires. The ordered array of the one-dimensional carbon chains packed parallel to one

another in hexagonal structures are oriented perpendicular to the substrate surface. In the carbon atom chains, each carbon atom is connected to the two nearest neighbors by the sp^1 bonds. Geometric characteristics of the two-dimensionally ordered linear-chain carbon nano-matrix is presented in Fig. 5.

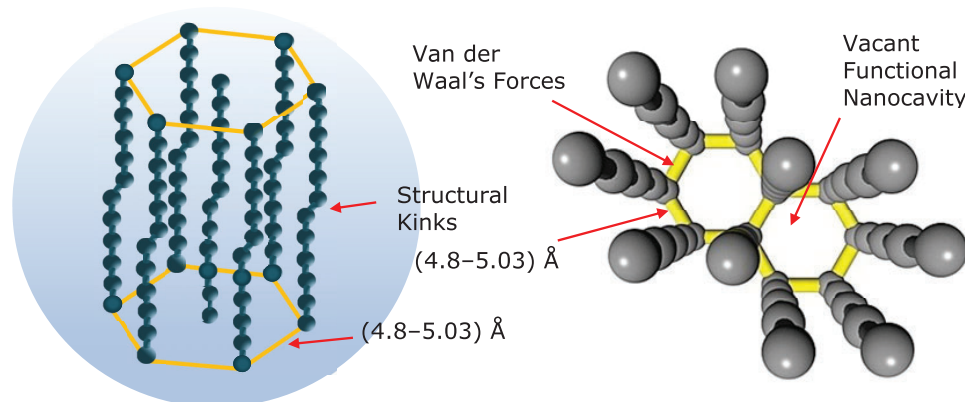

Figure 5: Geometric characteristics of the two-dimensionally ordered linear-chain carbon nano-matrix cell with the vacant functional nanocavity, available for the atomic nano-clusters assembling

The straight carbon chain becomes unstable as it lengthens. A carbon chain with self-forming kinks (see Fig. 5) is a more stable system (energetically more favorable) than a straight carbon chain.

To ensure the stability of the growing carbon chains, it is necessary to provide a special requirement for the plasma pulse specific energy. The electron temperature of the plasma should not exceed the bond breaking energy in carbon chains, since this leads to the “crosslinking” of these carbon chains and the formation of amorphous carbon with short-range order of the diamond or graphite type.

The specific energy of the plasma pulse should exceed the breaking energy of the sp^2 (614 kJ/mol) and the sp^3 bonds (348 kJ/mol), but should not exceed the breaking energy of the sp^1 bonds (839 kJ/mol) in the evaporating carbon chains.

At large thicknesses of the growing carbyne-enriched nano-matrix, the probability of the interchain interaction and the formation of crosslinks between the carbon chains increases. In this regard, the growing nano-matrix is stimulated by the argon ions and, with an increase in thickness, its structure is additionally stabilized by the hydrogen ions injected into the arc discharge plasma during the carbon condensation process.

Along the vertical axis, the electrical conductivity of the nano-matrix is metallic. Due to absence of coupling between the carbon chains along the longitudinal and transverse axes (where the van der Waals forces only exist) the nano-matrix demonstrates dielectric properties along these axes. Such a nano-matrix can be considered as an array of mutually-stabilizing CAWs, which also includes a set of different sp -phases that provides stabilization of the sp -hybridized carbon chains.

Two-dimensionally ordered linear-chain carbon nano-matrix represent a multi-cavity nanostructure, containing vacant functional nanocavities, available for assembling by atom clusters of various chemical elements. Schematic representation of the vacant functional nanocavity of the nano-matrix available for nano-clusters assembling is presented in Fig. 6.

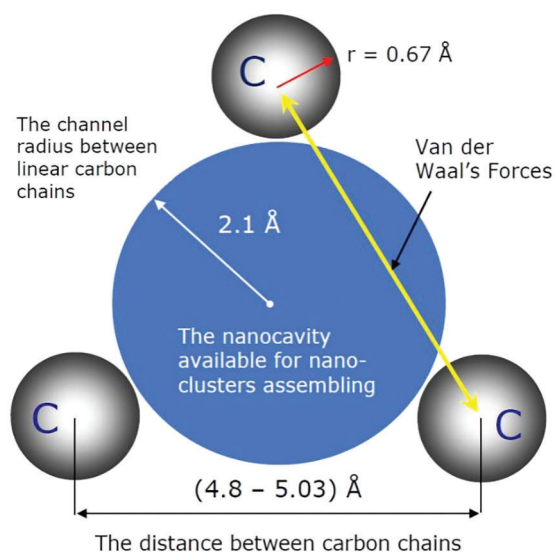

Figure 6: Schematic representation of the vacant functional nanocavity of the two-dimensionally ordered linear-chain carbon nano-matrix available for nano-clusters assembling

By cluster-assembling of the spatial structure of two-dimensionally ordered linear-chain carbon nano-matrix with various molecules, specific catalytic agents and chemical elements, the properties of the nano-matrix can be both modified or the new properties can be added. Cluster-assembly of the nano-matrix can occur both without chemical interaction (so called intercalation), and with rupture of the π bonds, which can lead to an additional reaction. For instance, by assembling the two-dimensionally ordered linear-chain carbon nano-matrix with calcium clusters, which suck up hydrogen molecules, creates a high-density, reversible hydrogen storage device. The two-dimensionally ordered linear chain carbon nano-matrix could serve as an efficient basis for designing and the growth of the new carbon-based nanostructured metamaterials with unique electrophysical, optical, structural, topographic, biological and chemical properties. The spatial structure of such a nano-matrix can also self-adjusts to the structure of the embedded atom clusters.

3 Pulse-Plasma Deposition Reactor for Growing of the Carbyne-Enriched Nanostructures

The cathodic arc plasma deposition (CAPD) or arc-PVD (PVD is physical vapor deposition) is a physical vapor deposition technique in which an electric arc is used to vaporize material from a cathode target. The vaporized material then condenses on a substrate, forming a two-dimensionally ordered linear-chain carbon nano-matrix. The experimental set-up for ion-assisted pulse-plasma deposition of the two-dimensionally ordered linear-chain carbon nano-matrix with capability of cluster-assembling by various chemical elements is presented in the Fig. 7.

The main components of the carbon pulse-plasma deposition reactor for growing of the carbyne-based nanostructures: vacuum chamber; pulse-plasma carbon generator; the ion source for ionic stimulation; target assembly with removable target material. The ion and plasma beams intersect at the substrate surface. The ion beam irradiation of the substrate surface forms bends in the attached carbon chains which stabilize the growing chain ensemble.

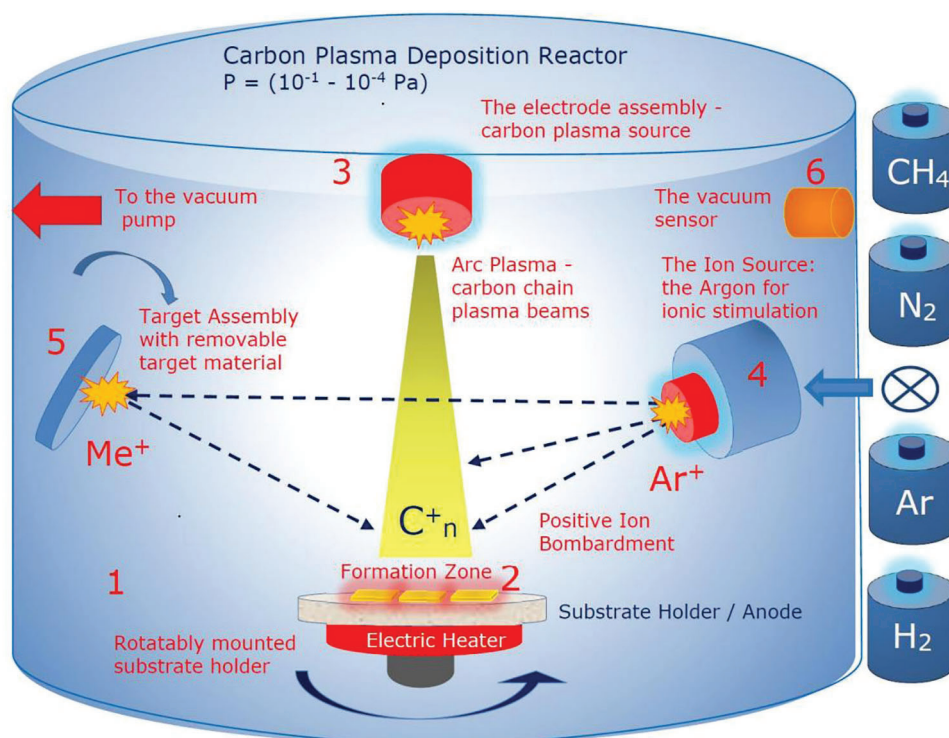

Figure 7: Schematic representation of the carbon pulse-plasma deposition reactor for growing the carbyne-based nanostructures: 1-vacuum chamber; 2-substrate; 3-pulse-plasma carbon generator (graphite cylindrical cathode of main discharge); 4-the ion source for ionic stimulation; 5-target assembly with removable target material; 6-vacuum sensor

The evaporation of the carbon plasma sheaf from the graphite cathode of main discharge 3 is caused by local heating of the graphite surface by electron bombardment to $T = 3000$ C. The chains of carbon atoms, C_n (where $n = 1, 2, 3, \dots$), formed in the plasma sheaf are directed by electrodes to impinge upon the surface of the substrate where the polycondensation of the carbon chains takes place. The schematic representation of the pulse-plasma carbon generator that was installed in the reactor of the experimental set-up (Fig. 7) is presented in Fig. 8.

An arc discharge is ignited between the cathode of main discharge 1 and anode of main discharge 2 (which are preferably separated by a voltage of about 200 V) by means of auxiliary discharge between the cathode of auxiliary discharge 6 and the cathode of main discharge 1 and the anode of auxiliary discharge 4 surrounding the cathode of main discharge 1. The auxiliary discharge is ignited by means of ignition electrode 5. The design of the cathode (item 1 in Fig. 8) depends on the purposes of deposition and can be manufactured as a composite structure, containing cylindrical rods from different materials, for instance, silver, tungsten, gold etc. The example of design of a cylindrical cathode of main discharge is presented on Fig. 9.

The capacitors C1 and C2 are connected to a power supply unit with varied voltage (100–300) V. The ignition electrodes are supplied by the pulsed voltage with an amplitude of 800 V. The inductance L is used to reduce the current growth rate to a required value. The growth of the carbon nano-matrix is enhanced by irradiation with Ar ions. The flux of Ar ions is formed by a low-pressure ion source, installed in a separate section of the deposition reactor chamber (see Fig. 7).

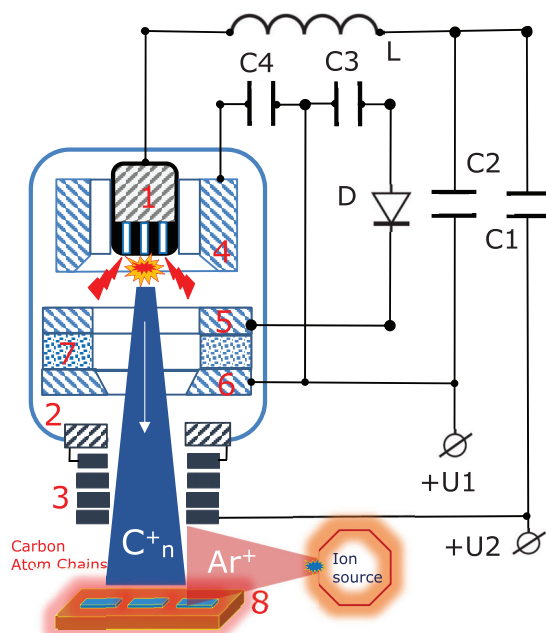

Figure 8: Schematic representation of the pulse-plasma carbon generator that installed in the reactor of the experimental set-up (Fig. 7): 1-a cylindrical cathode of main discharge (evaporated material, the high purity graphite); 2-anode of the main discharge; 3-a solenoid final focusing system with plasma neutralization; 4-second anode of auxiliary discharge; 5-ignition electrode; 6-cathode of auxiliary discharge; 7-dielectric insulator; 8-substrate holder

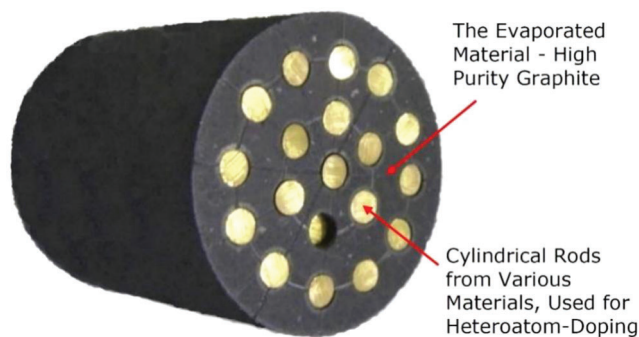

Figure 9: The example of design of a cylindrical cathode of main discharge, containing cylindrical rods from different materials, for instance, silver, tungsten, gold, etc. This is item 1 in Fig. 8

The energy of ions bombarding the substrate surface depends on the substrate bias voltage, being varied in the range (0–300) eV by both the carbon plasma parameters and the ion source extractor voltage, depending on the parameters of the plasma assisted deposition. The nano-matrix can be deposited onto Si wafer, metals, and NaCl single crystals at an ion energy of 150 eV. Before deposition, the reactor chamber was pumped down to the residual pressure of 10^{-4} Pa. The operating pressure during the deposition is 10^{-4} Pa. The structure of bonds in the grown carbon nano-matrices can be programmed by the processes of self-organization and auto-synchronization of the growing nanostructures. As a number of experiments show the sp¹-bonds and sp-hybridized carbon nanostructures are formed only in a narrow

range of optimal ion-assisted pulse-plasma deposition parameters. Hence, a challenging task is to simulate and optimize an ion-assisted pulse-plasma deposition procedure.

The thickness of the grown nano-matrix is programmed by the number of pulses, by the energy per pulse, the capacitance of the main discharge capacitors and by the charging voltage of these capacitors. The minimum coating thickness is 0.1–0.5 nanometers. With the deposition frequency of 1–5 Hz, the temperature of the samples does not reach more than 60–80 degrees Celsius.

4 Pattern Excitation Phenomena in the Model Experimental Systems

Pattern's excitation phenomena in the pulse-plasma deposition zone are programmed by interaction of several competing mechanisms, in particular, through the thermo-electric convection excitation, by the state of stress in the deposited nano-matrix and by self-synchronization of the self-excited oscillatory cells in the deposition region. Structural self-organization and pattern formation are the universal and key phenomena observed during growth and cluster-assembly of the carbyne-based nano-matrix at the ion-assisted pulse-plasma deposition. Self-organization phenomena are observed also during the cluster-assembling of the nano-cavities by atoms of various chemical elements due to formation of new chemical, interatomic and intermolecular bonds. The pulse-plasma deposition zone is a vibration-sensitive media for which the universal laws of Cymatics are valid [8].

Let's consider the examples of the self-organizing and pattern excitation phenomena for the model experimental systems. The examples of the self-organized patterns of excitation for the samples grown at various ion assistance energies are presented in Fig. 10. The fragments of the self-organized patterns observed for the samples grown at various ion assistance energies are based on the research results obtained in the paper [9].

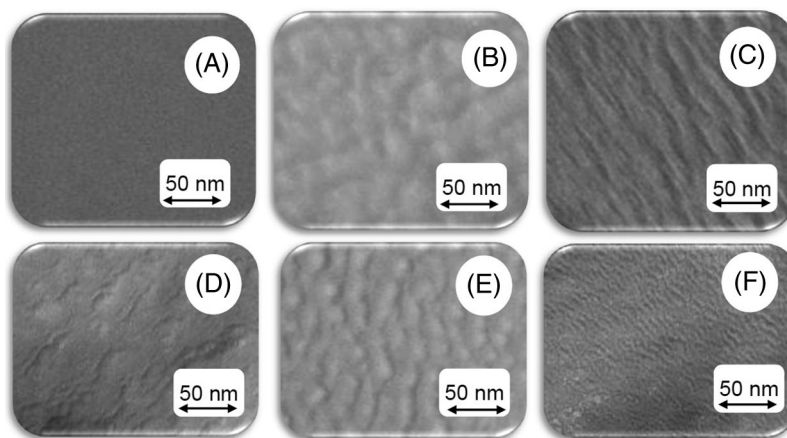

Figure 10: The fragments of the transmission electron microscopy (TEM) patterns of samples obtained in different conditions: (A)-0 eV, (B)-200 eV, (C)-300 eV, (D)-400 eV, (E)-600 eV, (F)-800 eV

Self-organization and formation of surface patterns are most pronounced when the grown system is supplied with additional energy and by nano-sized active centers. The transmission electron microscopy has shown that the structure of the sample deposited without ion assistance is homogeneous, while the structure of ion-assisted samples is heterogeneous. The specific conductivity of ion-assisted samples is (10^3 – 10^4) times larger than the conductivity of the samples deposited without ion assistance.

The transmission electron microscopy for case of assembling the two-dimensionally ordered linear chain carbon nano-matrix by silver nanoclusters has shown, that at increase of the energy flux into the deposition

region occurs decrease of the average size of the active nucleation centers at simultaneous increase in their numbers (see Fig. 11). The fragments of the transmission electron microscopy images of the samples deposited at different ion assistance energies are based on the research results obtained in the paper [10].

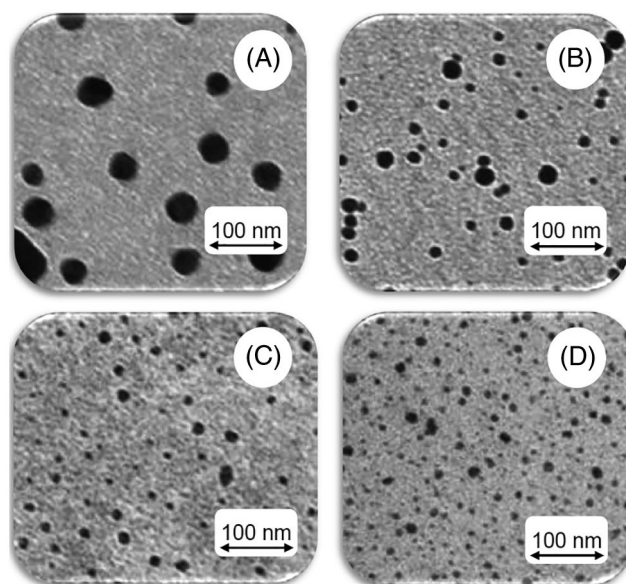

Figure 11: The fragments of the transmission electron microscopy (TEM) images of the samples deposited at different ion assistance energies: (A)-0 eV, (B)-100 eV, (C)-200 eV, (D)-300 eV

5 Model Experimental Systems for Study of Vibration-Assisted Deposition

The model experimental system demonstrates how vibrations provide significant influence on the structures of the deposited model nanomaterial. In the paper [11], Hristova-Vasileva et al. demonstrated a new approach of the evaporated material vibration-assisted thermal deposition in vacuum chambers. Earlier, in the papers [12,13] for the atomic deposition experiment were studied the nanoscale self-organization phenomena on the substrate surface using standing surface acoustic waves. With using molecular dynamics simulations were described the structuration physical driving mechanism. However, this research does not take into account the vacuum conditions influenced during the deposition processes. Acoustic waves cannot propagate in the low-pressure environment. At the same time, the acoustic waves can be transmitted from the vibration source to the solid as mechanical vibrations with specific frequency. In the result, the substrate mechanical vibrations during the deposition could influence the surface morphology and structure of the deposited nanomaterial. The selenium, having a variety of allotropic phases, is a convenient material for fundamental research of the mechanical vibrations influence during the nanostructure's deposition. Tellurium, as well as hexagonal selenium, is a typical crystalline semiconductor, whose atoms form polymeric, covalently bonded helical chains, packed into a hexagonal lattice through the van der Waals forces. Due to this specific nature of tellurium, during nanostructures deposition formation of the nanowires, nanotubes, nanorods, etc., is observed. Such kinds of specific nanostructures can be considered as the model experimental systems that can demonstrate fundamental phenomenon observed at vibration-assisted thermal deposition of the evaporated material in vacuum with acoustic wave frequency. During the nano-structures deposition, the mechanical oscillations were applied to the substrate with input frequencies of 0, 50, 150 and 4 kHz at the deposition rate of 0.3 nm/s, and the vacuum chamber pressure of 7×10^{-3} Pa.

As can be seen from the atomic force microscopy (AFM) images of 150 nm thick Tellurium nanostructures, presented on Fig. 12, the acoustic waves applied to the substrate results in morphological changes, demonstrating self-organization of the nanostructures. The images are based on the research results obtained in the paper [11].

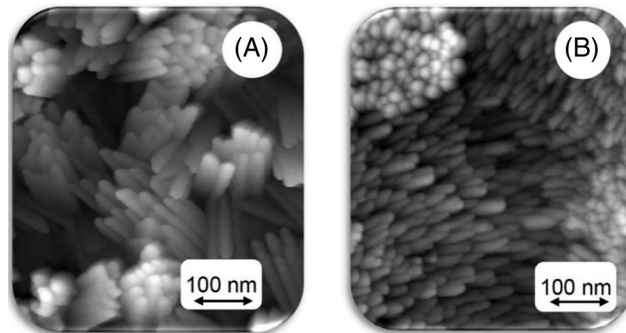

Figure 12: The fragments of the atomic force microscopy (AFM) images of 150 nm thick Tellurium nanostructures, deposited at mechanical vibration frequencies of 50 Hz (A) and 4 kHz (B)

The Fig. 13A corresponding to the mechanical vibrations frequency of 50 Hz demonstrates a graded and highly disoriented nanostructure. On the Fig. 12B corresponding to the mechanical vibrations frequency of 4 kHz is observed ordered columnar nanostructure. The images are based on the research results obtained in the paper [11].

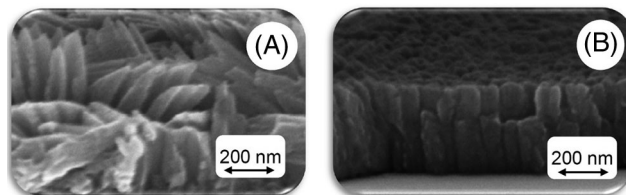

Figure 13: The fragments of the cross-section scanning electron microscopy (SEM) microphotographs of the Tellurium nanostructures with magnification of 105 times. During deposition were applied the following frequencies: 50 Hz (A) and 4 kHz (B)

6 Concept of Vibration-Assisted Activation the Pulse-Plasma Deposition Zone

Two-dimensionally ordered linear-chain carbon nano-matrix also can be considered as both acoustic and electromagnetic sensitive nanostructured metamaterial. The vibration of sp-hybridized carbon chains inside the multi-cavity nano-matrix occurs due to the van der Waals interactions between them. Each grown nano-matrix has a unique vibration signature formed by a set of individual CAWs [14].

As demonstrated by the model experimental systems, vibrational activation is capable of transforming the orientation of nanostructures in the grown nano-matrix. In the late 18th century, German physicist Chladni demonstrated the organizing power of sound and vibration in a visually striking manner. In the 1950s the study of wave phenomena was continued by Swiss scientist and anthroposophist Hans Jenny, who named the research field as “Cymatics” (“kyma” is the Greek word for wave) [8]. Under this term, he summarized all phenomena which appear when tone and sound meet the substance. The sound is both a wave and a geometric pattern at the same time. Hans Jenny, too, found that higher frequencies produced more complex shapes. As the frequency rises, the dissolution of one pattern may be followed

by a short chaotic phase before a new, more intricate, stable structure emerges. If the amplitude is increased, the motions become all the more rapid and turbulent, sometimes producing small eruptions. The shapes, figures and patterns of motion that appeared proved to be primarily a function of frequency, amplitude, and the inherent characteristics of the various materials. An interesting detail in Dr. Jenny's investigations into sound forms in fluids and gases is that if you first produce a disturbance in a fluid, gas or in a flame, then it becomes sensitive to the influence of sound.

The acoustic hologram generated in the nanostructure growth zone through external acoustic activation is capable of controlling the growth process, cluster-assembling and formation of chemical bonds. In accordance with universal laws of Cymatics and Unified Template (Mereon Matrix) approach, during the vibration-assisted activation of the pulse-plasma deposition region occurs excitation of the self-organized patterns in accordance with 3-dimensional universal template. The Mereon Matrix is a 3-dimensional template of a dynamic geometric process [15,16]. The structure of material systems is formed on the basis of the universal template, the form of which is defined by presence of vibrations in the system. Connection between shape and vibration determined through the Mereon Matrix. Accordingly, for the case we are considering, the formation of the carbyne-enriched nano-matrix structure occurs in accordance with the universal template patterns, described by the Cymatics laws. The unique properties of the nanostructured metamaterials arise not from the properties of the forming initial materials, but from the specific design of their arrangement, geometry and orientation.

The geometrical structure of the metamaterials is usually including a repeated pattern at a scale that is smaller than the wavelengths of the phenomena they influence. Nanostructured metamaterials demonstrate unique properties determined by their geometrical structure. With taking into account the high sensitivity of the structure of a two-dimensionally ordered linear-chain carbon that represent a multi-cavity nano-matrix to ultrasonic vibrations [7], we propose the innovative concept, connected with application of the universal Cymatics phenomena and predictive excitation of self-organizing and pattern formation during the vibration-assisted growth and cluster-assembling of the carbyne-enriched nanostructured metamaterials. Each carbyne-enriched nano-matrix has a unique vibration signature formed by a set of individual carbon chains in the multi-cavity nano-matrix.

Sp-hybridized carbon chains vibrate similar to an elastic string. Like the tuning of a guitar string, this vibration can be predicted based on length and tension (Fig. 14).

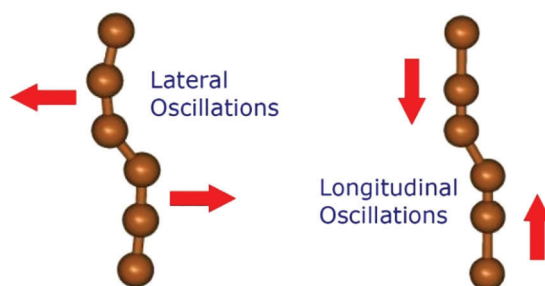

Figure 14: Schematic representation of the lateral and longitudinal oscillations of the sp-hybridized carbon chains

The analysis of such a carbyne-enriched nano-matrix that can be performed with Raman spectroscopy goes beyond just simple chemical classification. The Raman spectrum reflects the nano-material's crystallinity with a good degree of precision. A Raman spectrum of a multi-cavity nano-matrix will contain a series of peaks that correspond to the different vibrational modes in a molecule. The position and linewidth of these peaks can be so unique to a system that they are considered a "fingerprint" for the

molecular species. Certain frequencies of acoustic vibrations are capable of forming various geometric shapes. This universal law can be used to program the structure of the grown nano-matrix. Since the carbyne-enriched nano-matrix is an acoustically sensitive material, we propose to use acoustic activation of the pulse-plasma zone of nano-matrix growing. At vibrating disturbance onto a pulse-plasma deposition zone will occur initiation of sensitivity of this medium to the influence of vibrations. In particular, we propose the technology for the patterning and control of the nanostructure growth onto acoustically excited piezoelectric substrates through application of the inverse piezoelectric effect.

Assisting the plasma deposition of the nano-matrixes with acoustic waves leads to patterning phenomena characterized by substantial lateral changes in nanostructure, thickness and properties [17]. In addition, changes in crystal structure are also induced. There exist two basic types of the bulk acoustic waves. The first one is the longitudinal wave, in which the oscillations of the particles are only in the direction of the wave propagation. The second one is the shear wave, in which the particle displacements are orthogonal to the wave propagation. The size and distribution of pattern formation can be controlled through the adjustment of deposition parameters and acoustic wave properties.

Changing the acoustic driving frequency can be employed to modify the pattern size. The piezoelectric elements and layers are also capable of generating electromagnetic radiation [17]. Acoustic and electromagnetic holograms with specified frequency and spatial characteristics are capable of providing spatial marking of the structure of the grown carbyne-enriched nanostructures. The use of combinations of vibrations in different frequency ranges makes it possible to purposefully control the nanostructure of the grown metamaterial. The new synergistic effect will be provided through the vibration-assisted self-organized wave patterns excitation along with simultaneous manipulating by their properties through the electromagnetic field. Interaction between the inhomogeneous electric field distribution generated on the vibrating layer and the plasma ions will serve as the additional energizing factor controlling the local pattern formation and self-organizing of the nano-structures. Application of the inverse piezoelectric effect during the ion-assisted carbon pulse-plasma deposition can be provided through the deposited piezoelectric layer (see Fig. 15).

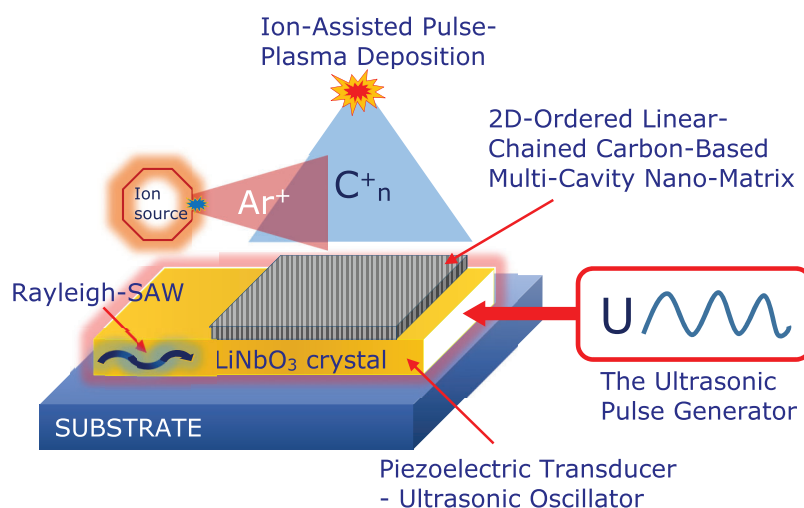

Figure 15: Schematic representation of application of the inverse piezoelectric effect during the ion-assisted carbon pulse-plasma deposition

The piezoelectric layer converts the released electric energy into mechanical acoustic oscillations that propagate through the substrate and growing nano-matrix. Applying an alternating current or radio frequency excitation to electrodes patterned on a piezoelectric material, generates an acoustic wave that propagates in the direction perpendicular to the surface of the deposited nano-structure into the bulk medium (bulk acoustic wave) or along the surface of the deposited nanostructure (surface acoustic wave). Different acoustic exciting frequencies and waveforms, generated by the piezoelectric layers can be used for programming the required geometric configurations and sizes of the nanostructure of the grown metamaterials. Simultaneous application of the direct and inverse piezoelectric effect opens possibility for interactive ion-assisted pulse-plasma growth the carbon-based nanostructured metamaterials (see Fig. 16).

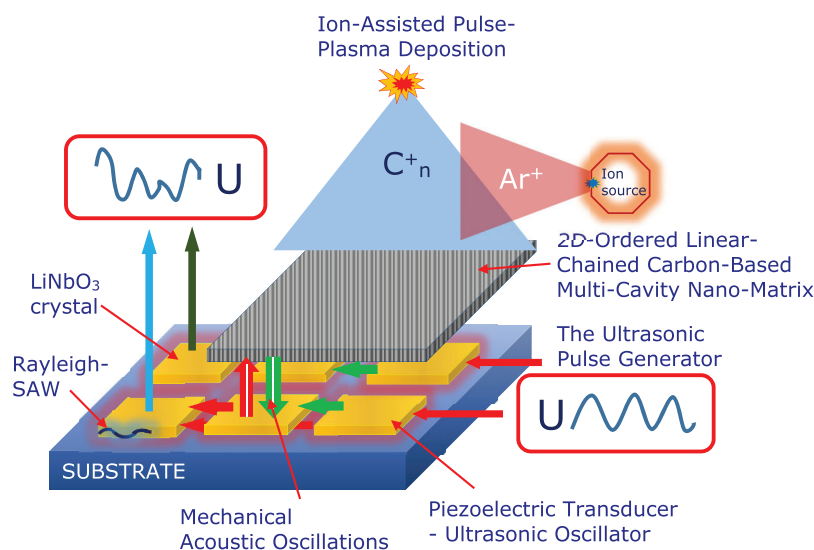

Figure 16: Application of the direct and inverse piezoelectric effect for nano-structural monitoring system during the ion-assisted pulse-plasma deposition

Using direct and inverse piezo effects in the nano-structural monitoring system, one piezo transducer is electrically excited to induce vibration which can be detected by a multitude of piezo transducers operated in the sensor mode. By estimating and comparing the excitation signal and the various sensor output signals, it is possible to obtain information regarding the current state of the grown nanostructure. The new fundamental possibilities for predictive programming both by the spatial structure and physics-chemical properties of the functionalized carbyne-enriched nanostructured metamaterials is connected with application of the data-driven carbon nanostructures genome approach. In accordance with the data-driven carbon nanostructures genome approach, for every specific carbon nanostructured metamaterial, there is a specific set of universal relationships like as: “Growth Regimes-Structure-Properties”, that allows one to unambiguously predict the main characteristics of the nanostructures under design and the technological regimes required for their predictive growth. Data-driven genome approach opens new possibilities for programming of the spatially controlled growth, structural self-organizing and cluster-assembling of the two-dimensionally ordered linear chain carbon nano-matrix during the ion-assisted pulse-plasma deposition.

7 Conclusion

Our research demonstrates how vibrations, frequency and energy flux can change and program the nano-structure of the growing carbyne-enriched nanostructured metamaterials. Two-dimensionally ordered linear chain carbon nano-matrix could serve as an efficient basis for designing and the growth of the new

carbyne-enriched nanostructured metamaterials with unique properties. Structural self-organization and pattern formation are the universal and key phenomena observed during growth and heteroatom-doping of the carbyne-enriched nano-matrix at the ion-assisted pulse-plasma deposition. Manipulating by the self-organized patterns excitation we can provide controllable growth and programming of the properties of the functionalized carbyne-enriched nanostructured metamaterials. Fundamental improvement of the ion-assisted pulse-plasma deposition technology for increased stability of the grown carbyne-enriched nano-matrices is connected with application of the controllable vibrational-acoustic and electro-magnetic activation of the plasma deposition region. Application various acoustic exciting frequencies and waveforms, generated in the 2D-ordered linear-chain carbon-based functionalized nano-carriers grows zone excite and creates specific unified templates for grows of the nano-structures and can be used for programming the required nano-architecture of the grown functionalized nano-carriers. Acoustic and electromagnetic holograms with specified frequency and spatial characteristics are capable of providing spatial marking of the structure of the grown carbyne-enriched nanostructures. With the use of the carbyne-enriched nanomaterials we can design the new nanomaterials with unique properties through heteroatom-doping technology.

Acknowledgement: This research work is jointly supported and funded by the Scientific and Technological Research Council of Turkey (TÜBİTAK) and the Russian Foundation for Basic Research (RFBR) according to the Research Project No. 20-58-46014.

Funding Statement: This research work is jointly supported and funded by the Scientific and Technological Research Council of Turkey (TÜBİTAK) and the Russian Foundation for Basic Research (RFBR) according to the research Project No. 20-58-46014. Authors who received the grant: Dr. Alexander Lukin and Prof. Oğuz Gülseren. URLs to sponsors' websites: The Russian Foundation of Basic Researches (RFBR)-<https://www.rfbr.ru/rffi/eng>; The Scientific and Technological Research Council of Turkey (TÜBİTAK)-<https://www.tubitak.gov.tr/>.

Conflicts of Interest: The authors declare that they have no conflicts of interest to report regarding the present study.

References

1. Heimann, R. B., Evsyukov, S. E., Kavan, L. (1999). *Carbyne and carbynoid structures*. Dordrecht: Springer Science. DOI 10.1007/978-94-011-4742-2.
2. Hirsch, A. (2010). The era of carbon allotropes. *Nature Materials*, 9(11), 868–871. DOI 10.1038/nmat2885.
3. Zhang, K., Zhang, Y., Shi, L. (2020). A review of linear carbon chains. *Chinese Chemical Letters*, 31(7), 1746–1756. DOI 10.1016/j.ccllet.2020.03.019.
4. Shi, L., Rohringer, P., Suenaga, K., Niimi, Y., Kotakoski, J. et al. (2016). Confined linear carbon chains as a route to bulk carbyne. *Nature Materials*, 15(6), 634–639. DOI 10.1038/nmat4617.
5. Tschannen, C. D., Gordeev, G., Reich, S., Shi, L., Pichler, T. et al. (2020). Raman scattering cross section of confined carbene. *Nano Letters*, 20(9), 6750–6755. DOI 10.1021/acs.nanolett.0c02632.
6. Delodovici, F., Choi, D. S., Al Fahim, M., Burchfield, L. A., Manini, N. (2019). Carbon sp chains in diamond nanocavities. *Physical Chemistry Chemical Physics*, 21(39), 21814–21823. DOI 10.1039/C9CP03978C.
7. Aleksandrov, A. F., Guseva, M. B., Savchenko, N. V., Streletskii, O. A., Khvostov, V. V. (2015). *The film of two-dimensionally ordered linear-chain carbon and method of its production*. Moscow: Federal Institute of Industrial Property.
8. Jenny, H. (2001). *Cymatics: A study of wave phenomena and vibration*. Newmarket, NH: MacMaroMedia Publishing.

9. Streletskiy, O. A., Zavidovskiy, I. A., Nischak, O. Y., Dvoryak, S. V. (2020). Electrical conductivity and structural properties of a-C:N films deposited by ion-assisted pulse-arc sputtering. *Thin Solid Films*, 701, 137948. DOI 10.1016/j.tsf.2020.137948.
10. Streletskiy, O. A., Zavidovskiy, I. A., Nischak, O. Y., Haidarov, A. A. (2020). Size control of silver nanoclusters during ion-assisted pulse-plasma deposition of carbon-silver composite thin films. *Vacuum*, 175, 109286. DOI 10.1016/j.vacuum.2020.109286.
11. Hristova-Vasileva, T., Bineva, I., Dinescu, A., Arsova, D., Nesheva, D. (2016). “Cymatics” of selenium and tellurium films deposited in vacuum on vibrating substrates. *Surface and Coatings Technology*, 307, 542–546. DOI 10.1016/j.surfcoat.2016.09.042.
12. Taillan, C., Combe, N., Morillo, J. (2011). Nanoscale self-organization using standing surface acoustic waves. *Physical Review Letters*, 106(7), 076102. DOI 10.1103/PhysRevLett.106.076102.
13. Taillan, C., Combe, N., Morillo, J. (2015). Chladni figures at the nanoscale. *European Physical Journal B: Condensed Matter and Complex Systems*, 88(12), 1–14. DOI 10.1140/epjb/e2015-60695-x.
14. Ding, D., Zhao, Y., Dong, S., Yu, P., Wang, L. et al. (2017). The vibration of a linear carbon chain in carbon nanotubes. *Materials*, 10(5), 478. DOI 10.3390/ma10050478.
15. Dennis, L., Brender, M. J., Kauffman, L. (2013). *The mereon matrix: Unity, perspective and paradox*. Elsevier: Amsterdam, The Netherlands.
16. McNair, J., Dennis, L., Kauffman, L. (2018). *The mereon matrix: Everything connected through (K)nothing*, Singapore: World Science Publishers. DOI 10.1142/10805.
17. Garca-Valenzuela, A., Fakhfour, A., Oliva-Ramrez, M., Rico-Gavira, V., Rojas, T. C. et al. (2021). Patterning and control of the nanostructure in plasma thin films with acoustic waves: Mechanical vs. electrical polarization effects. *Materials Horizons*, 8(2), 515–524. DOI 10.1039/D0MH01540G.