

Graph Visualization Toolkits

Ugur Dogrusoz
Bilkent University

Qingwen Feng and Brendan Madden
Tom Sawyer Software

Michael Doorley
Wilde Technologies

Arne Frick
Accenture

In fields such as software engineering, telecommunications, and financial analysis, researchers and developers have commonly used graphs to model relational information. For example, many computer-aided software engineering (CASE) tools use graphs to model the dependencies between modules in a large program. (These graphs are typically drawn as diagrams in which each node—object—is a small rectangle with a text annotation inside and each edge—relations or links—is a line segment between a pair of nodes. Figure 1 shows an example of a program’s visualization.) Further examples of such diagrams are various UML diagrams for software modeling, data-flow diagrams, PERT charts, and Entity-Relationship (E-R) diagrams in database systems. The

usefulness of the relational model depends on whether the graph drawing, or layout, effectively conveys the relational information to the users. A poorly drawn diagram confuses the application user, but a well laid out diagram helps the user comprehend the data.

Because user systems have grown larger and become more complicated, manually laying out graphs has become not only difficult and tedious but also ineffective in terms of human and computer resources. This has motivated a great deal of research in automatic graph drawing.¹ Since graphical user interfaces (GUIs) have improved and more state-of-the-art software tools have incorporated visual functions, interactive graph editing and diagramming facilities have become important components in visualization systems.

At Tom Sawyer Software (see <http://www.tomsawyer.com>), we have created two toolkits that allow developers to easily integrate graph visualization capabilities into custom software applications. The Graph Layout Toolkit (GLT) provides interfaces for

We describe the Graph Layout Toolkit and Graph Editor Toolkit, which provide a framework for graph visualization useful in a broad array of application areas.

1 Visualization of a program’s call graph.

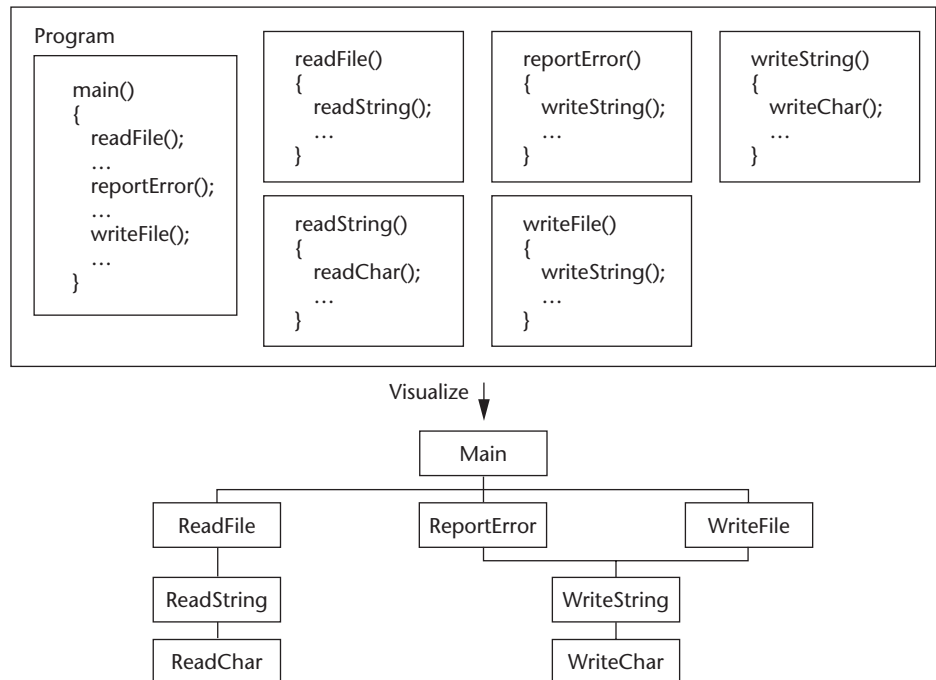

Additional Graph Drawing Tools

Much research and development conducted in this area over the past few decades have resulted in graph drawing tools and libraries in universities and the industry.

AGD is a library of algorithms for graph drawing (see <http://www.mpi.sb.mpg.de/AGD>).¹ The library offers a broad range of algorithms for 2D graph drawing, in particular planar drawing and planarization methods and tools for implementing new algorithms. AGD is an object-oriented, modular, and extendible library implemented in C++ and based on LEDA (see <http://www.algorithmic-solutions.com>) and Abacus.²

GDToolkit is a graph drawing toolkit designed to efficiently manipulate several graph types and to automatically draw them according to many different aesthetic criteria and constraints (see <http://www.dia.uniroma3.it/~gdt>). GDToolkit is composed of

- the Graph Application Programming Interface (GAPI), an object-oriented C++ library providing the advanced developer with a hierarchy of graph classes encapsulating as methods a wide set of graph algorithms;
- the Batch Layout Generator (BLAG), a batch application that reads an input file describing the topology of the graph to be drawn, applies the algorithms and the constraints specified in a configuration file, and generates an output file defining a layout of the input graph; and
- some interactive demos providing a graph editor and a set of advanced algorithms for automatic layout.

Graphviz is an open-source graph drawing system³ that includes several components (see <http://www.research.att.com/sw/tools/graphviz/>):

- *dot* makes hierarchical layouts of directed graphs,
- *neato* makes spring model layouts of undirected graphs,
- *lefty* is a two-view graphics editor for technical pictures,
- *dotty* is a customizable interface written in lefty,

- *tcldot* is a customizable graphical interface written in TCL 7.6, and
- *libgraph* is the base library for graph tools.

Graphviz tools are standalone and can also be extended to create interfaces to external databases and systems. This usually involves writing *dotty* or *tcldot* scripts to customize the graph editor's behavior and to program it to communicate with external files or programs.

Other tools include Graphlet (<http://www.infosun.fmi.uni-passau.de/Graphlet>),⁴ Graph Drawing Server (<http://www.cs.brown.edu/cgc/cgc-brown.html>),⁵ and GraphPack.⁶

References

1. C. Gutwenger et al., *Graph Drawing Algorithm Engineering with AGD*, tech. report TR-186-1-00-02, Algorithms and Data Structures Group, Inst. of Computer Graphics and Algorithms, Vienna Univ. of Technology, 2000.
2. M. Jünger and S. Thienel, *Introduction to ABACUS – A Branch-And-Cut System*, tech. report 97.263, Univ. of Köln, Köln, Germany, 1997.
3. E.R. Gransner and S.C. North, "An Open Source Graph Visualization System and Its Applications to Software Engineering," *Software Practice and Experience*, vol. 30, no. 11, 2000, pp. 1203-1233.
4. M. Himsolt, "Graphlet: Design and Implementation of a Graph Editor," *Software: Practice and Experience*, vol. 30, 2000, pp. 1303-1324.
5. S. Bridgeman, A. Garg, and R. Tamassia. "A Graph Drawing and Translation Service on the WWW," *Graph Drawing (Proc. GD 96)*, S. North, ed., Lecture Notes in Computer Science 1190, Springer-Verlag, Berlin, 1997, pp. 45-52.
6. M.S. Krishnamoorthy et al., "Graphpack: Design and Features," *Software Visualization: Series on Software Engineering and Knowledge Engineering*, P. Eades and K. Zhang, eds., vol. 7, 1996, pp. 83-99.

modeling, drawing, and automatically laying out graphs. The Graph Editing Toolkit (GET) provides a customizable display and editing layer, which facilitates rapidly developing tools that visualize data in the form of graphs. (See the "Additional Graph Drawing Tools" sidebar for other approaches.)

In this article, we present an architectural overview of these tools and discuss the challenges encountered during implementation and integration of theory and research results into such tools. In particular, we discuss automatic graph layout and labeling algorithms and complexity management techniques. In addition, we present examples of applications using these tools.

Automatic graph layout

Graph layout comes in different flavors depending on the application type and the data being visualized. The graphs include trees (such as directory structures), directed graphs (such as PERT charts), and general graphs (such as network maps). Drawing styles include straight-line and orthogonal drawings (such as data-

base schema). Such differences between the graphs and drawing styles require highly specialized layout algorithms. For instance, algorithms used to perform a layout of a flowchart differ from those used for a database schema representation.

GLT provides a graph model and a drawing framework and offers four different layout styles: hierarchical, orthogonal, symmetric, and circular (see Figure 2, next page). Each style addresses the needs of various software applications. We've put theoretical results into practice by first studying and improving them for generality, efficiency, breadth, and extendibility. For instance, many popular layout algorithms can only handle a certain type of a graph (for example, simple connected graphs as opposed to disconnected multigraphs) or have execution times not acceptable for an interactive graph visualization tool. In addition, we equipped each library with a set of *tailoring options* that facilitate customizing the layout algorithm. GLT is independent of any display or graphics software, thereby providing users with design flexibility.

2 Examples of (a) circular, (b) orthogonal, (c) hierarchical, and (d) symmetric layouts.

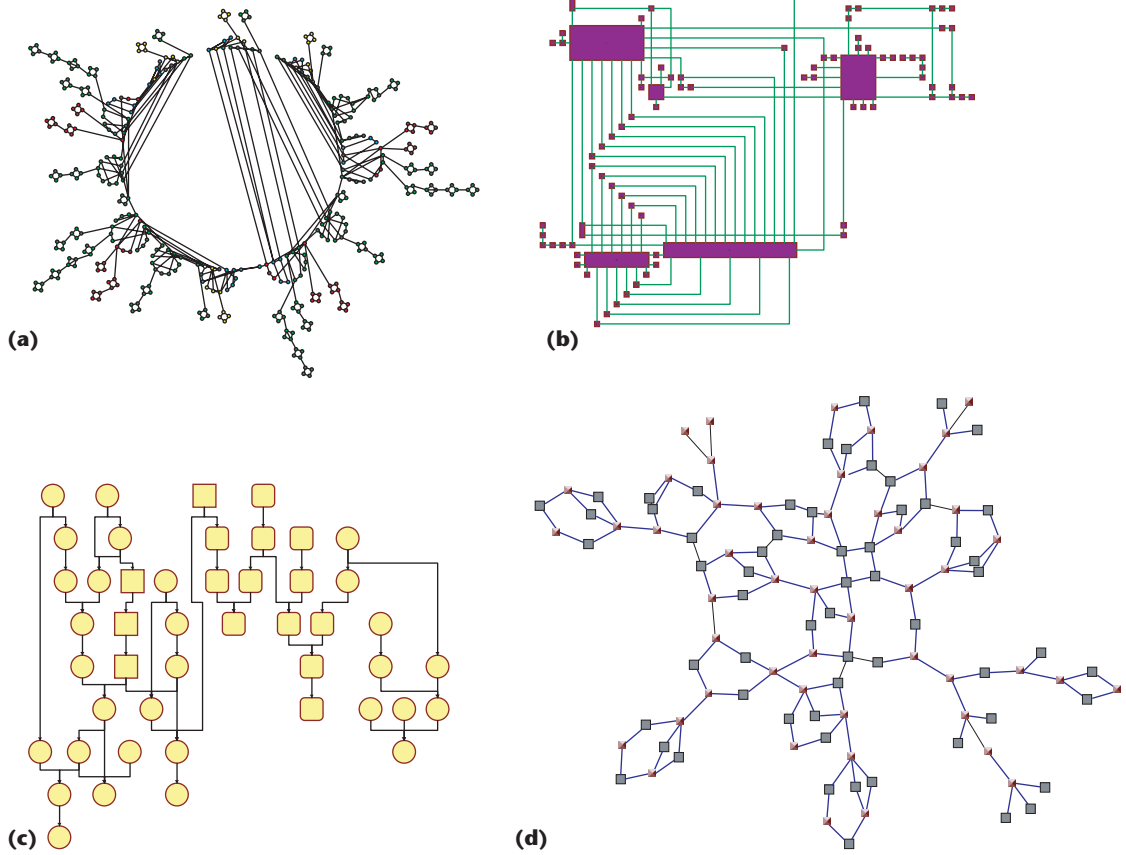

Hierarchical layout

The hierarchical layout library reveals precedence relations by positioning the nodes in a graph based on the direction in which edges are oriented (see Figure 2c). Nevertheless, it allows the existence of cycles and detects a minimal number of edges that are oriented against the hierarchy's flow. Cycle detection makes the hierarchical library suited for reverse engineering and compiler applications. The layout algorithm that we use is based on the one described by Sugiyama, Tagawa, and Toda.² We can tailor the algorithm by choosing appropriate parameters for graph orientation, node justification and alignment, and several spacing parameters. Its attractive features include orthogonal routing and port specification:

- *Orthogonal routing.* This feature draws hierarchical graphs in which edges run horizontally and vertically along a grid (see Figure 2c). Flowcharts often use orthogonal routing.
- *Port specification.* This feature allows for the specification of attachment locations on nodes, which is important in many complex diagramming applications where a node might contain several fields (see Figure 3).

The hierarchical library is versatile because many relationships between objects are based on precedence. It's particularly suited for drawing call graphs and for use in compiler development. Configuration management,

process modeling, and workflow are other areas for which the style is appropriate.

Orthogonal layout

The orthogonal layout library produces high-clarity drawings, using only horizontal and vertical line routing (Figure 2b). It maintains at most one bend per edge, except in the case of reflexive edges. The library is particularly useful in applications that require fast layout and don't require drawings to show inherent hierarchical structures. The orthogonal library's efficient algorithms³ produce drawings with relatively few crossings. It allows minimal stretching of nodes that have a high number of incident edges, and there's no overlap between nodes or between nodes and nonincident edges. Users can set tailoring options to preserve the input node width and height as specified or to preserve the specified aspect ratio. Tailoring controls also specify the spacing between parallel edges and between nodes.

The orthogonal drawing style is widely used in CASE tools. Consequently, this style has many applications in the areas of data and process analysis and design (such as database design, data warehousing, and business-process modeling), CAD, and object-oriented analysis and design.

Symmetric layout

The symmetric layout library uses force-directed heuristics⁴ to expose the natural symmetry inherent in many graphs. The algorithm computes near-congruent drawings of isomorphic graphs, provides a uniform

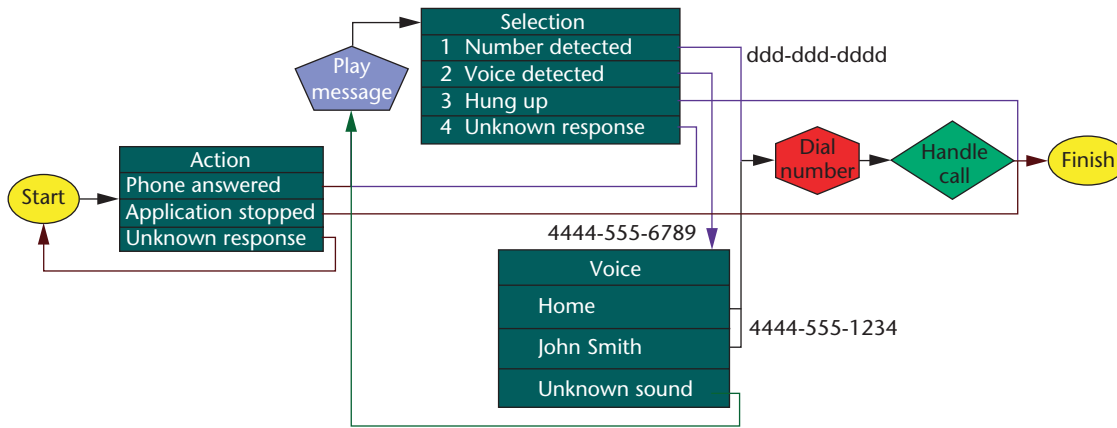

3 An example of nodes with ports.

node distribution, and produces drawings with relatively few edge crossings (Figure 2d).

The algorithm isn't as efficient as those of the hierarchical and orthogonal libraries, but it produces high-quality drawings when graphs are reasonably sparse and node sizes don't vary widely. It has applications in network management, Web visualization, bioinformatics, and software engineering diagrams based on undirected graphs, including E-R diagrams.

Circular layout

The circular layout library produces graph layouts that emphasize group structures. The layout algorithm partitions the nodes into clusters based on a number of flexible grouping methods.⁵ It places each cluster of nodes on circles according to the logical interconnection of these clusters (see Figure 2a). The circular library supports stable clustering techniques while respecting application-specific groupings. In addition, users can set minimum and maximum values for the number of nodes to be grouped in each cluster.

Many changes to the input graph have no effect on the clusters produced in subsequent layouts, resulting in drawings that remain relatively stable when changes are made. The circular layout technique mainly targets networking and systems management but is also useful in other areas where clustering is applicable and helpful in depiction of systems, such as in criminology and Web visualization.

Positioning edge labels

Just as diagram formatting is a time-consuming and monotonous task, so is positioning labels. Thus, GLT includes algorithms for automatically placing edge labels⁶ (see Figure 4, next page). The algorithms strive to eliminate ambiguity and improve clarity and flexibility. A label associated with one edge mustn't overlap any other edge or any node. Relationships between edges and labels should be easily identified without cluttering the drawing. Thus, GLT positions labels close to, but not overlapping, edges if possible. In addition, it provides considerable flexibility in meeting user constraints on the placement of labels with an extensive set of interfaces. For example, in some applications, a label must be associated with the source node or target node of an edge.

Features of the edge labeling facility include support for automatic label positioning for all layout styles. GLT additionally supports an interactive labeling framework so that if the application lets users move edges, the edge labels are suitably repositioned. Finally, GLT includes interfaces to associate several labels with each edge and position them automatically. This is a recurring requirement in diagrams. For example, E-R diagrams frequently need to provide separate edge annotations for each of the two end points of the edge.

GET architecture

In designing a generic toolset to enable the development of diagram-based visualization applications, we distinguished between standard, customizable, and application-specific user interface components in the GET architecture:

- Standard features are uniform across all applications and include graph display, scrolling and zooming, graph layout and editing (such as selection; drag; resize; and cut, copy, and paste), and printing. These features tend to be time-consuming to implement. In particular, graph layout is a difficult problem. GET not only provides layout, but its design ensures that layout concepts are easily integrated with the other common user interface features.
- Customizable features result from requirements that are common across all applications, but they're satisfied in different ways. We provided a framework to enable the toolkit to be instantiated with a particular set of views (for example, when a node has color, border thickness, and text fields), event (such as a mouse event) responses, dialog items, and secondary windows. Implementing these requirements generally isn't a difficult task for an experienced graphics programmer using a framework such as the Microsoft Foundation Class (MFC) library. However, the need for flexibility is important, so we must take care in the toolkit design to place flexibility over functionality.
- Application-specific components vary across applications. Most graph visualization tools are complex, requiring interaction between a repository and a user interface. GET allows flexibility in application design.

4 Layout with automatic label positioning.

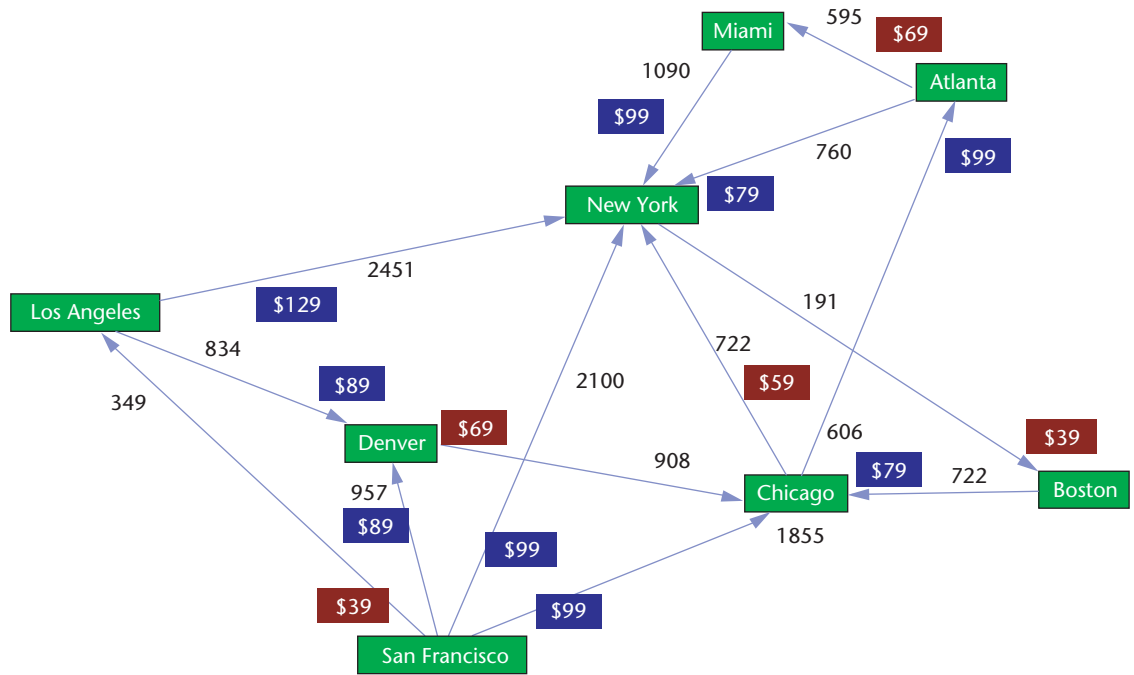

5 Role of GET within a graph visualization application.

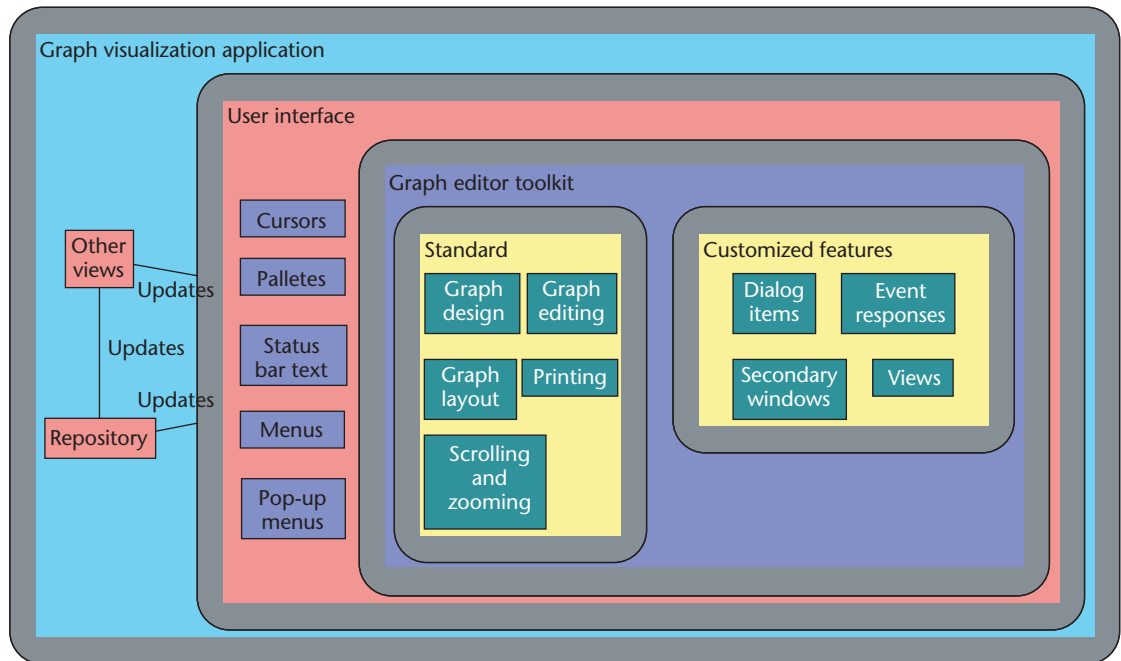

It should slot into, rather than take over, the application. Application developers can include the toolkit in a document/view architecture. In this case, the developer has complete control over the document design and can use the toolkit's graph window as a view. The application is then free to deal with issues such as interacting with the repository, providing other views (such as text browsers) of the repository and user interface (such as menu, cursor, and palette design).

Figure 5 illustrates the role played by these components in a typical graph visualization application. Figure 6 shows a GET sample application that application developers tailor to their requirements.

Complexity management

A single graph is often insufficient to represent information because of its overwhelming size or limitations imposed by application semantics.⁷ We can organize such information to span several graphs with relation-

ships among them. We refer to such relationships as navigation relationships, and they involve three distinct problems: partitioning, visualizing the navigation structure, and simplification.

Partitioning

How can we compose such a navigation structure? There are two extremes. In some cases, the partitioning is imposed, for example, by the development method for leveling data-flow diagrams. In other cases, we can apply techniques such as graph partitioning algorithms. Many applications, such as in software reengineering, can use techniques from both extremes.⁷ GLT provides minimal support for partitioning.

Visualizing the navigation structure

When visualizing the navigation structure, we can consider three levels of increasing complexity:

- *Navigation through multiple windows.* In this case, a node in a graph navigates to a child graph. The application can show the child graph in a different window. This doesn't present a layout problem because a layout is never performed on more than one graph at a time.
- *Navigation through nesting.* This model, supported by both GLT and GET, lets each graph have an independent coordinate space but lets a child graph be (optionally) drawn nested within its parent node (see Figure 7).
- *Compound graphs.* According to this model, an edge can connect nodes in different graphs. We optionally draw a child graph nested within its parent node. This requires specialized layout algorithms that provide techniques for routing the intergraph edges.

Simplification

In some cases, it's impossible to use navigation, probably because the semantics of the application don't allow

it. Simpler techniques such as hiding and folding are available in GLT and GET. Such techniques let us temporarily remove nodes and edges from the display and

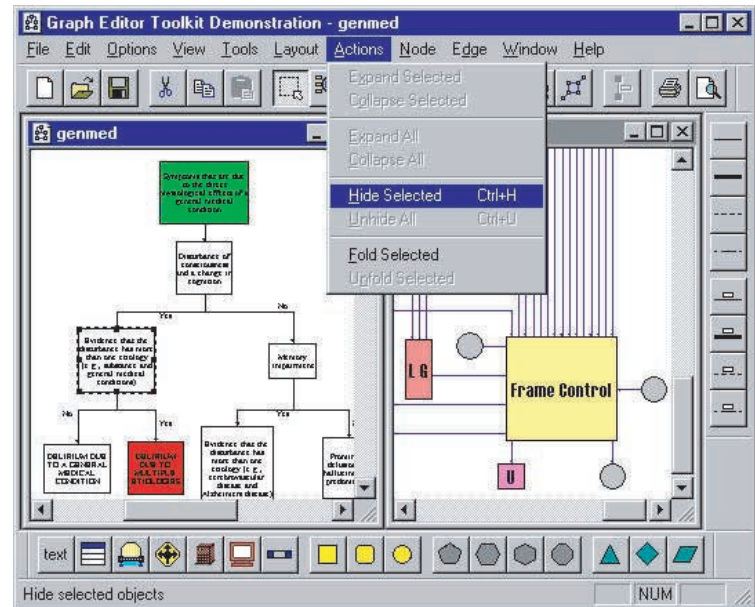

6 Graph Editor Toolkit example application.

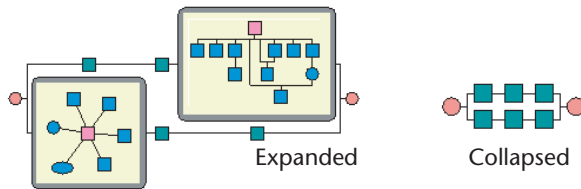

7 Example of nesting capability.

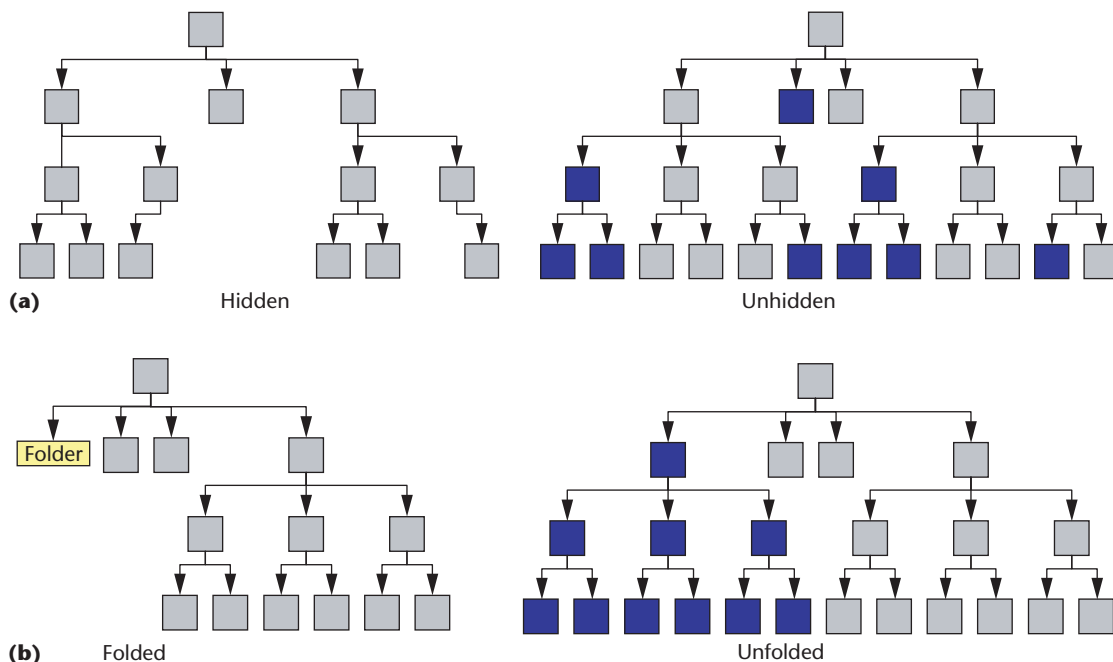

8 Hiding and folding examples.

9 Screen shot from LANsurveyor.

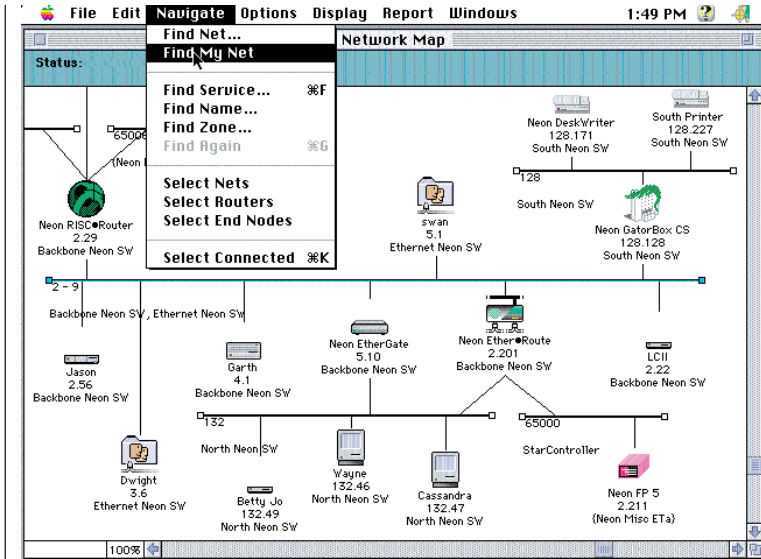

Courtesy of Neon Software

10 Screen shot from ESP Workstation.

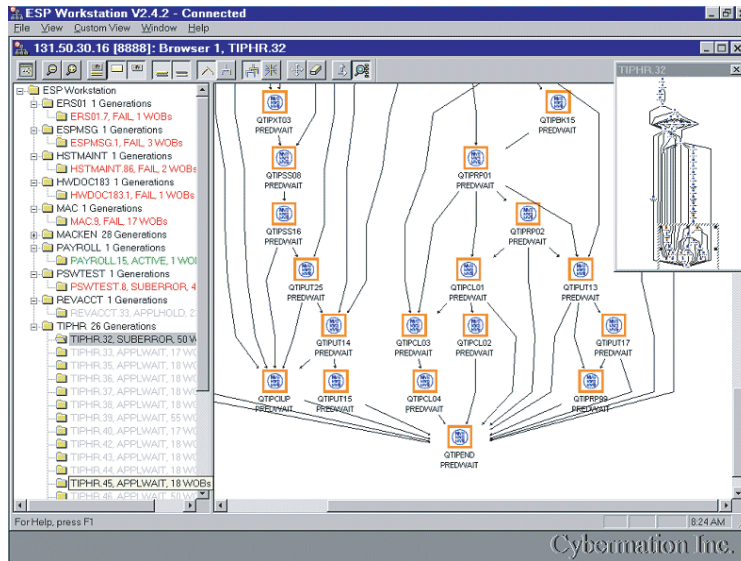

Courtesy of Cybermation

nodes (see Figure 9).

In another application, ESP Workstation, the GUI for Cybermation's ESP Workload Manager product, uses GET to create a diagrammatic user interface for visually depicting large-scale job scheduling (see Figure 10). Casting the problem as a graph results in thousands of nodes that represent tasks, and each task node can have up to 100 outgoing edges that represent dependencies with other tasks. In this application, hierarchical layout was the appropriate choice of style to give users a clear visual picture of how jobs are organized and how each job affects the other. The GET handles functions such as object positioning, line routing, and user interaction.

Lastly, ERwin is a data modeling application (from Logic Works) that uses GLT to support interactive visual database rule design. Our automatic layout algorithms help eliminate undesirable visual artifacts such as table overlap. Automatic layout increases the rate at which designers can make changes to the data model, letting them visualize the addition or deletion of tables as well as any edited relationships between these tables. The GLT-based interface improves designers' understanding of the model.

Challenges

Several challenging problems arise in the development of graph visualization techniques. We believe that these problems are important, and solving them will improve next-generation graph visualization applications:

optionally replace them with a new folder node. We can later reintroduce them (Figure 8).

This simple technique is powerful. For example, it lets a call-graph user hide a routine that's called by almost every other routine or fold together all of the functions that come from the same library. Both of these techniques let the user and the application developer implement their concepts of abstraction.⁸

Applications

We designed GLT and GET to let developers quickly integrate graph visualization functionality into an application, enhancing the usability of their tools. Here, we present several example uses of our toolkits. For example, the network management software application LANsurveyor—a network management software application from Neon Software for the Macintosh that maps AppleTalk networks—uses GLT to automatically display and navigate through the logical relationships between network objects such as nets, routers, and end

■ *Incremental layout.* It's crucial to preserve a mental picture of a graph's drawing over successive layouts. It can be distracting to make a slight modification, perform a layout, and have the resulting drawing significantly differ from the previous drawing. We've developed incremental layout algorithms for our symmetric and hierarchical libraries and are working on supporting them for other libraries.

■ *Constraints.* Even though most of the information to be drawn is logical, many applications enforce certain physical placement requirements on nodes. These requirements range from fixing one or both of the location coordinates of some objects to clustering a specified group of objects. Limited support for constraints, such as restricting a node to a specific layer in a layered hierarchical drawing, is available with GLT. We're working on a more generalized constraint framework for all our libraries.

- *Complexity management.* We've started investigating the partitioning and compound graph drawing problems we referred to earlier. Adding these techniques to the toolsets will significantly advance the value of graph visualization.
- *Graphical syntax support.* We'll extend GET to let the application developer specify which types of objects can have relationships. For example, a requirement in the design of an application to draw data-flow diagrams might be to disallow a data flow between two data stores. The current model doesn't have direct support for this. It requires a richer form of subtyping than the notion of views GET currently supports.

More functionality addressing these challenging problems have been integrated into GLT and GET version 4.0, and more work is underway. ■

Acknowledgment

The National Institute of Standards and Technology (NIST) Advanced Technology Program grant, number 70NANB5H1162, partially supported this research.

References

1. G. DiBattista et al., *Graph Drawing, Algorithms for the Visualization of Graphs*, Prentice-Hall, Upper Saddle River, N.J., 1999.
2. K. Sugiyama, S. Tagawa, and M. Toda, "Methods for Visual Understanding of Hierarchical Systems," *IEEE Trans. Systems, Man, and Cybernetics*, vol. 21, no. 2, Feb. 1981, pp. 109-125.
3. T.C. Biedl, B.P. Madden, and I.G. Tollis, "The Three-Phase Method: A Unified Approach to Orthogonal Graph Drawing," *Graph Drawing* (Proc. GD 97), G. DiBattista, ed., Lecture Notes in Computer Science 1343, Springer-Verlag, Berlin, 1998, pp. 391-402.
4. T. Kamada and S. Kawai, "An Algorithm for Drawing General Undirected Graphs," *Information Processing Letters*, vol. 31, no. 1, Apr. 1989, pp. 7-15.
5. U. Dogrusoz, B. Madden, and P. Madden, "Circular Layout in the Graph Layout Toolkit," *Graph Drawing* (Proc. GD 96), S. North, ed., Lecture Notes in Computer Science 1190, Springer-Verlag, Berlin, 1997, pp. 92-100.
6. U. Dogrusoz et al., "Edge Labeling in the Graph Layout Toolkit," *Graph Drawing* (Proc. GD 98), S.H. Whitesides, ed., Lecture Notes in Computer Science 1547, Springer-Verlag, Berlin, 1998, pp. 356-363.
7. M. Doorley and A. Cahill, "Experiences in Automatic Levelling of Data Flow Diagrams," *Proc. 4th Workshop Program Comprehension*, IEEE CS Press, Los Alamitos, Calif., 1996, pp. 218-229.
8. D. Kimelman et al., "Dynamic Graph Abstraction for Effective Software Visualization," *Australian Computer J.*, vol. 27, no. 4, Nov. 1995, pp. 129-137.

For further information on this or any other computing topic, please visit our Digital Library at <http://computer.org/publications/dlib>.



Ugur Dogrusoz is an assistant professor of computer engineering at Bilkent University, Ankara, Turkey. He was the Vice President of Engineering as well as a researcher and developer at Tom Sawyer Software for three years. His research interests include graph visualization, combinatorial optimization, and bioinformatics. He received his PhD from the Computer Science Department of Rensselaer Polytechnic Institute, Troy, New York.



Qingwen Feng is a product manager at Tom Sawyer Software where she works on the research and development of relational information visualization technologies. She has a PhD in computer science from the University of Newcastle, Australia. She was the recipient of the 1997 Australian Distinguished PhD Dissertation in Computer Science Award.



Brendan Madden is the CEO of Tom Sawyer Software and has spent 15 years developing commercial quality graph visualization systems. He previously worked at the IBM TJ Watson Research Center, where he was the lead designer and developer of two of IBM's graph layout systems. He has a BS in engineering physics from Cornell University.



Michael Doorley is a software engineer at Wilde Technologies in Dublin, Ireland, where his interests include modeling and visualization of component-based systems. He previously worked in graph layout and editing at Tom Sawyer Software and had done research in the software reengineering field. He has a PhD in computer science from the University of Limerick.



Arne Frick is a manager with Accenture. At the time of this research, he was a research staff member at Tom Sawyer Software, where he applied his research in Symmetric graph layout techniques in the context of a commercial product. He has a PhD in informatics from the University of Karlsruhe, Germany.

Readers may contact Ugur Dogrusoz at Bilkent Univ., Computer Eng. Dept., Office EA-528, Ankara 06533, Turkey, email ugur@cs.bilkent.edu.tr.